



- VOLTAGE RANGE FROM 150kV ~300kV
- VOLTAGE & CURRENT PROGRAMMING
- SAFETY INTERLOCK
- DIGITAL INTERFACE-ETHERNET AND RS-232
- OEM CUSTOMIZATION AVAILABLE

## INTRODUCTION

Wisman' s DH Series of 2kW high voltage power supplies are available in positive or negative polarities in 19 different models with outputs ranging from 150kV to 300kV. A full featured front panel allows easy local control, while an extensive analog interface provides comprehensive remote capability. The standard Ethernet and RS-232 digital interfaces simplify integrating the DH into your system design. The active power factor correction circuit has high efficiency while minimizing line-related EMI interference.

Provides network ports, RS-232, RS-485 and analog interfaces, simplifying the integration of OEM systems. Comprehensive fault diagnosis protection circuit includes overvoltage, overcurrent, Short circuit, overtemperature, arcing, etc.

## TYPICAL APPLICATIONS

Accelerator, capacitor charging, electron beam, ion beam, ion implantation, semiconductor manufacturing, lithography technology, aging of electronic components, high voltage insulation test, static Electrical applications, lasers, high-power RF transmitters, X-ray systems, scientific experiments, industrial applications. Laboratory Applications, Industrial Applications.

## DH SELECTION TABLE

kV	mA	P(kW)	MODEL	kV	mA	P(kW)	MODEL
150	13.3	2	DH150*2	180	11.1	2	DH180*2
160	12.5	2	DH160*2	200	10.0	2	DH200*2
300	6.67	2	DH300*2				

\*Substitute "P" or positive polarity and "N" for negative polarity.

## DH SELECTION EXAMPLE

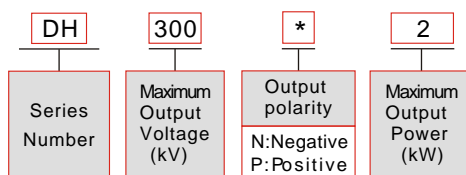

HARDWARE BASED OPTIONS	
BFP	Blank Front Panel
HST	High Stability
LL(X)	High Voltage Cable Length

SOFTWARE CONFIGURABLE FEATURES	
AOL	Adjustable Overload Trip
AX	Arc Trip Count
AQX	Arc Quench Time
ARX	Arc Re-Ramp Time
CPC	Constant Power Control
APT	Adjustable Power Trip
SSX	Slow Start Ramp Times

## DH SPECIFICATIONS

PARAMETER	DESCRIBE
Input	180~264Vac, 10A maximum Current ,47Hz~63Hz.
Output	150kV~300kV Maximum output Voltage option.
Stability	0.02% per hours after 1/2 hour warm-up.
Ripple	0.05% p-p+1Vrms
Voltage/Current Monitor	0 ~ +10Vdc corresponds to 0 to maximum output, accuracy:±1%.
Voltage Local Programming	Internal potentiometer to set voltage from 0 to maximum output voltage.
Voltage Remote Programming	0 ~ +10Vdc proportional from 0 to maximum output voltage.
Current Local Programming	Internal potentiometer to set current from 0 to maximum output current.

RACK MOUNT



## DH SPECIFICATIONS

Current Remote Programming	0 ~ +10Vdc proportional from 0 to maximum output current.
Voltage Load Regulation	0.05%+500mV ( no load to full load change).
Voltage Line Regulation	±0.05%+50mV (input voltage line change±10%).
Current Load Regulation	0.05%±100uA (no load to full load change).
Current Line Regulation	±0.05% (input voltage line change±10%).
Temperature Coefficient	≤25ppm/°C.
Operating Temperature	0°C~+50°C.
Storage Temperature	-40°C~+85°C.
Humidity	20%~85% RH, non-condensing.
Metering	Digital voltage and current meters, accurate to within 1%.
HV Output Connector	A detachable long shielded HV cable is provided.
Input/Output Connector	DB50, contain control and monitor signal.
Dimensions (150~160kV)	10.5" (6U)H X 19" W X 22" D (266mm x 482.5mm x 558mm).
Dimensions (180~200kV)	10.5" (6U)H X 19" W X 23" D (266mm x 482.5mm x 584mm).
Weight(150~160kV)	40kg.
Weight(180~200kV)	68kg.

1

RACK MOUNT

## DH ANALOG INTERFACE

PIN	SIGNAL	PARAMETERS
1	Signal Ground	Optional
2	Polarity Indicator	Ground=Inhibit, Open=HV On
3	External Interlock	+15Vdc at Open, <15mA at Closed
4	External Interlock Return	External Interlock Return
5	Current Monitor	0~+10Vdc=0to maximum output. Zout=4.99kΩ
6	Voltage Monitor	0~+10Vdc=0to maximum output. Zout=4.99kΩ
7	+10Vdc	+10VDC, 1mA Max
8	Remote Current Program In	0~+10Vdc=0to maximum output. Zin=10MΩ
9	Local Current Program Out	Front Panel Program Current
10	Remote Voltage Program In	0~+10Vdc=0to maximum output. Zin=10MΩ
11	Local Voltage Program Out	Front Panel Program Voltage
12	Power Monitor	Optional
13	Remote Power Program In	
14	Local HV Off Out	+15Vdc at Open, <25mA at Closed
15	HV Off	Comment to HV OFF for FP Operation
16	Remote HV On	+15Vdc, 10mA Max=HV Off
17	Remote HV Off Indicator	0=HV On, +15Vdc, 10mA Max=HV Off
18	Remote HV On Indicator	0=HV Off, +15Vdc, 10mA Max=HV On
19	Remote Voltage Mode	Open Collector, Low = Active
20	Remote Current Mode	Open Collector, Low = Active
21	Remote Power Mode	Optional
22	Remote PS Fault	0=Fault, +15Vdc, 0.1mA Max=No Fault
23	+15Vdc Output	+15Vdc, 100mA Max
24	Power Monitor	Optional
25	Power Supply Common	Chassis Ground

## RS-232/RS-485 DIGITAL INTERFACE <sup>D</sup>

PIN	SIGNAL
1	N/C
2	TXD/Transmit Data
3	RXD/Receive Data
4	N/C
5	Digital Ground
6	N/C
7	RS-485B
8	N/C
9	RS-485A

## ETHERNET DIGITAL INTERFACE <sup>D</sup>

PIN	SIGNAL	PARAMETERS
1	RX+	Receive Data+
2	RX-	Receive Data-
3	TX+	Transmit Data+
4	N/C	No Connection
5	N/C	No Connection
6	TX-	Transmit Data-
7	N/C	No Connection
8	N/C	No Connection

## DH DIMENSIONS

DIMENSIONS: in.[mm]

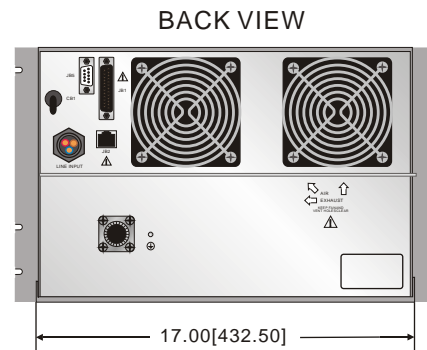
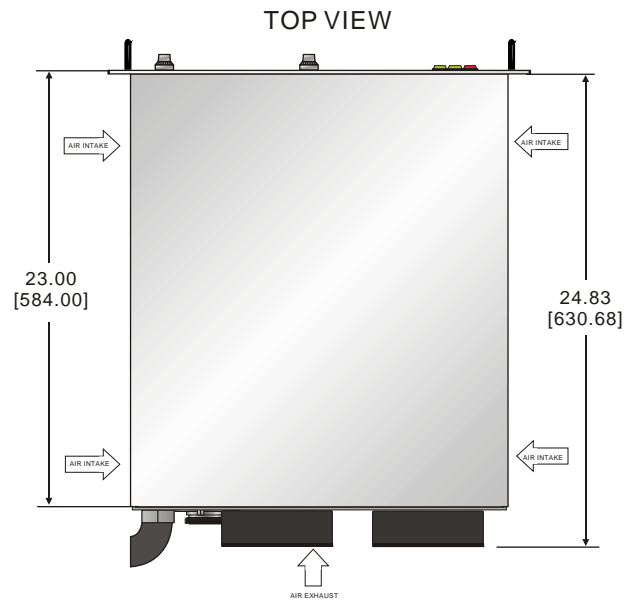
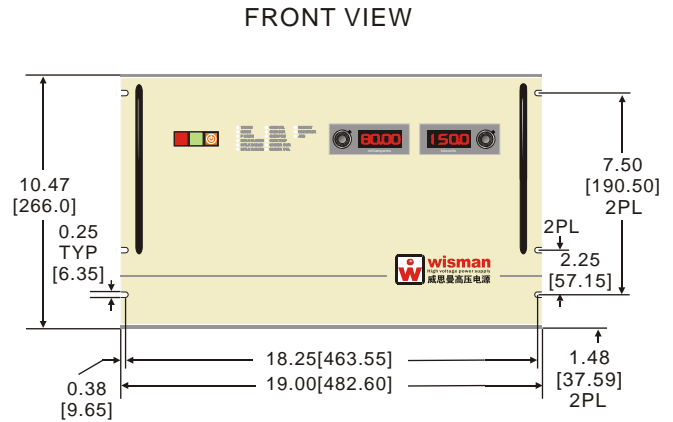
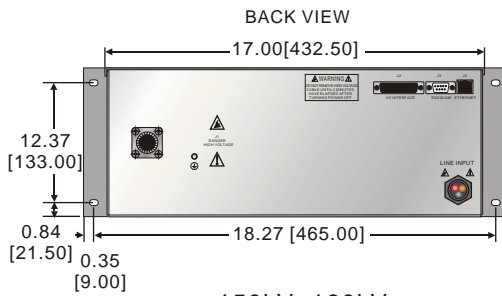
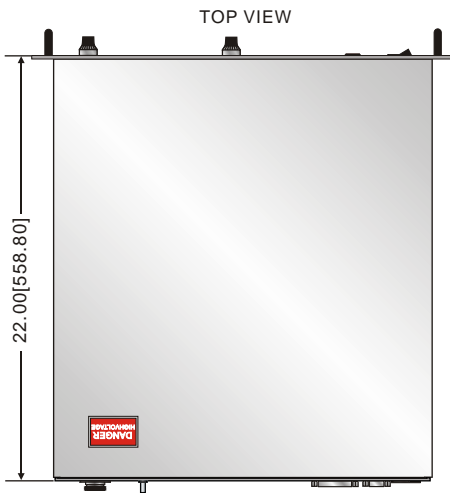
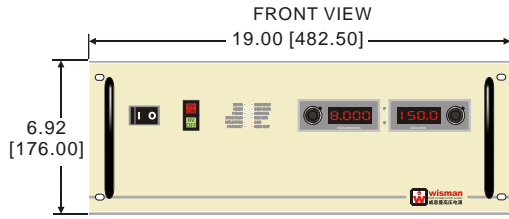

180kV~200kV

RACK MOUNT