

- OPTIONAL ETHERNET,RS-232 OR RS-422 IS AVAILABLE
- ±1kV~±30kV,0~300uA,REMOTELY PROGRAMMABLE
- POLARITY REVERSIBLE UPON COMMAND IN <1S AT NO LOAD
- LOW STORED ENERGY, CURRENT LIMITED OUTPUT
- COST EFFECTIVE MODULAR DESIGN
- LOCAL AND REMOTE CONTROL
- OEM CUSTOMIZATION AVAILABLE



CUSTOM APPLICATION

INTRODUCTION

Wisman's PRE is a full feature rack mountable high voltage power supply ideal for laboratory usage. It's designed to meet the needs of applications requiring a hot switched reversible output voltage. The output polarity can be quickly and safely reversed via a front panel switch. Excellent load and line regulation specifications along with outstanding stability and low ripple of the PRE assure a stable high voltage output for consistent process results.

An optional ETHERNET、RS-232 or RS-485 is available.

TYPICAL APPLICATIONS

Mass Spectrometry, Capillary Electrophoresis, Electron Microscope, Electrostatic Printing, Electron Multiplier Tubes, Ion Multiplier Tubes, Electrostatic discharge Testing, Electrostatic research, DNA Analysis, Microchip Electrophoresis, Microchip Electrophoresis, Electrospinning, Electrostatic chuck, Life Sciences, Medical, chemical Applications, Science, Laboratory Applications, Industrial Applications.

PRE SELECTION TABLE

kV	mA	P(W)	MODEL	kV	mA	P(W)	MODEL	kV	mA	P(W)	MODEL
5	1	5	PRE5R5	15	0.33	5	PRE15R5	25	0.2	5	PRE25R5
	1.2	6	PRE5R6		0.4	6	PRE15R6		0.24	6	PRE25R6
	1.6	8	PRE5R8		0.53	8	PRE15R8		0.32	8	PRE25R8
	2	10	PRE5R10		0.67	10	PRE15R10		0.4	10	PRE25R10
10	0.5	5	PRE10R5	20	0.25	5	PRE20R5	30	0.17	5	PRE30R5
	0.6	6	PRE10R6		0.3	6	PRE20R6		0.2	6	PRE30R6
	0.8	8	PRE10R8		0.4	8	PRE20R8		0.27	8	PRE30R8
	1	10	PRE10R10		0.5	10	PRE20R10		0.33	10	PRE30R10

PRE SELECTION EXAMPLE

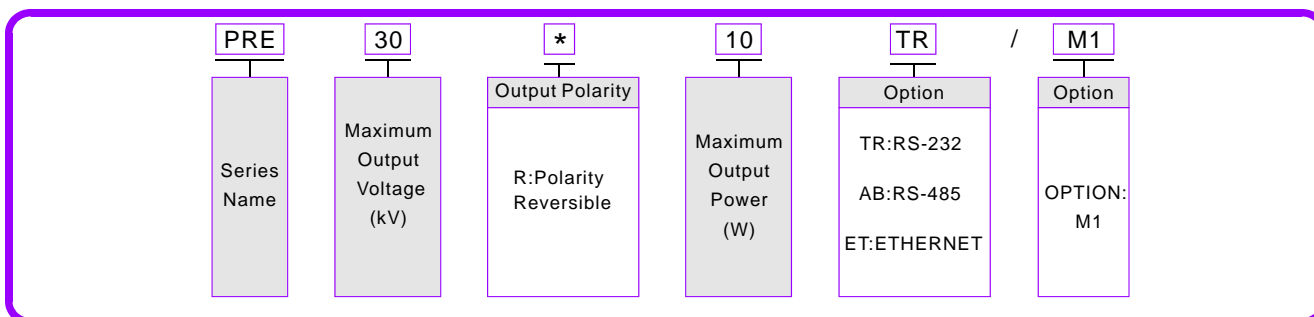



PRE SPECIFICATIONS

PARAMETER	DESCRIBE
Input	86Vac~256Vac,50/60Hz.
Output	±1kV, ±2kV, ±3kV, ±5kV, ±8kV, ±10kV, ±12kV, ±14kV, ±15kV, ±18kV, ±20kV, ±30kV Maximum output Voltage option.
Stability	0.01% per hour after 1 hour warm up.
Temperature Coefficient	≤25ppm/°C.
Ripple	≤0.001%Vp-p.
Polarity	Remotely reversible via logic signal.
Voltage/Current Monitor	0~+10Vdc corresponds to 0 to maximum output, Zout=10k? accuracy:±1%.
Voltage Programming	0~+10Vdc proportional from 0 to maximum output voltage, Zin=10M? .
Voltage Load Regulation	0.01% (no load to full load change).
Voltage Line Regulation	±0.01% (input Voltage line change±10%).
Current Load Regulation	0.01% (no load to full load change).
Current Line Regulation	±0.01% (input Voltage line change±10%).
Operating Temperature	0°C~+40°C.
Storage Temperature	-40°C~+85°C.
Cooling	Convection cooled.
Humidity	20%~85% RH, non-condensing.
Dimensions	1.73" H x 19.00" W x 17.42" D(44mm x 482.5mm x 442.5mm). Option:M1:4.72" H x 7.09" W x 11.02" D(120mm x 180mm x 280mm).
Weight	7.5kg~10kg.

PRE ANALOG INFORMATION

Jb1	SIGNAL		JB1	SIGNAL	
1	GND	GND	14	Current Monitor	0~+10Vdc=0 to full scale,Zout=10k?
2	HV Enable	GND=HV ON,OPEN=HV OFF	15	Ground Fault Indicator	Open collector pulled up internally to +15Vdc, Through 4.7k resistor with a 470Ω limiting Resistor in series. Transistor OFF=signal active.
3	SGND	SGND			
4	Return Current Monitor	0 ~ +10Vdc=0 to 100% rated output current,as measured returned from load.Zout=10 k? 1%.	16	N/C	No Connection.
5	Load Return	Required for GFI circuit functionality.	17	N/C	No Connection.
6	Voltage Monitor	0~+10Vdc=0 to full scale,Zout=10k?	18	N/C	No Connection.
7	Reset	Low=Reset.	19	HV OFF STAT	Low=HV OFF
8	Polarity Control	Open =Positive , Grounded =Negative .	20	HV ON STAT	Low=HV ON.
9	+10Vdc	+10Vdc Reference Output	21	Fault Indicator	Open Collector, Low = Active
10	Voltage Program in	0~+10Vdc=0 to full scale,Zin=10M?	22	I Mode Indicator	Open Collector, Low = Active
11	Voltage Program out	0~+10Vdc=0 to full scale	23	V Mode Indicator	Open Collector, Low = Active
12	Current Program in	0~+10Vdc=0 to full scale,Zin=10M?	24	HV OFF Indicator	High=HV OFF
13	Current Program out	0~+10Vdc=0 to full scale	25	HV ON Indicator	High=HV ON

ETHERNET DIGITAL INTERFACE ^①

SIGNAL		SIGNAL	
1	RX+	6	N/C
2	RX-	7	TX-
3	TX+	8	N/C
4	N/C	9	N/C

RS-232/RS-485 DIGITAL INTERFACE ^②

SIGNAL		SIGNAL	
1	N/C	6	N/C
2	TXD/Transmit Data	7	RS-485B
3	RXD/Receive Data	8	N/C
4	N/C	9	RS-485A
5	SGND		



PRE DIMENSIONS

ISO9001:2015

DIMENSIONS:in.[mm]

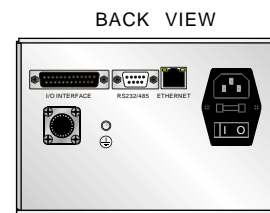
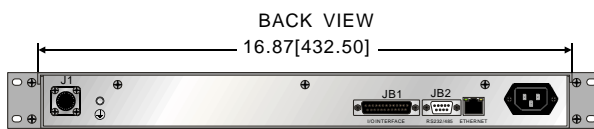
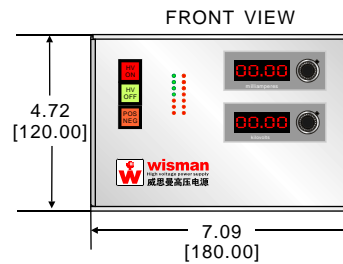
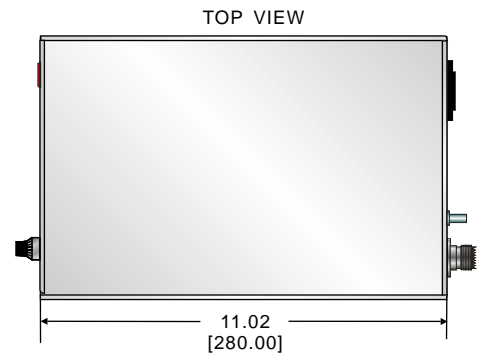
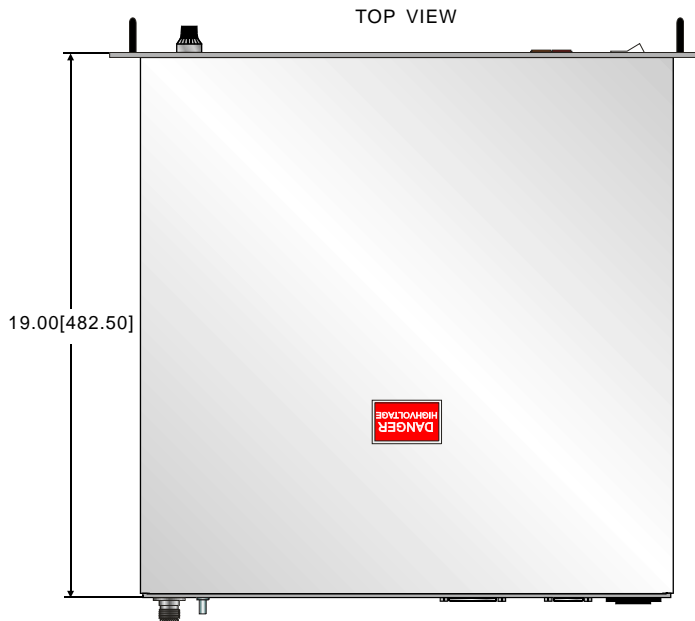
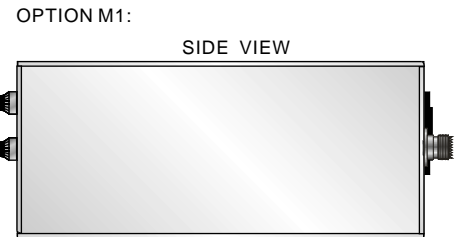
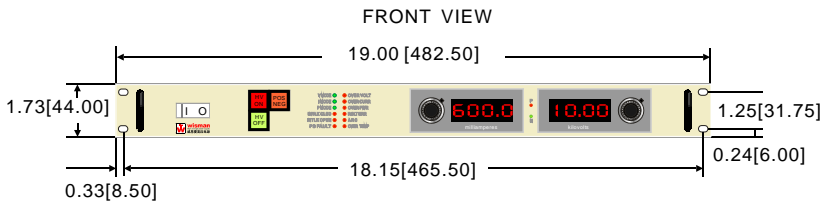

CUSTOM APPLICATION